

THE PERFECT SOLUTION

ATMOSEAL®



ADJUSTABLE CURTAIN FOR TRAILERS WITH VARIED HEIGHT.

CUSTOM SIZED TO INSURE A PERFECT SEAL.

BACKING IS MADE WITH THE HIGHEST QUALITY PRESSURE TREATED WOOD.

YELLOW GUIDE STRIPE IS VULCANIZED (HEATSEALED); NOT SEWN.

LONG LASTING AND LOW MAINTENANCE.

ADJUSTABLE "SPLIT" CURTAIN IS AN AVAILABLE OPTION.

EXTRA LONG LASTING, HIGH QUALITY VINYL WITH U.V. STABILIZER TO PREVENT FADING AND CRACKING.

SPECIALLY SELECTED, HIGH DENSITY MEMORY FOAM REDUCES DAMAGE BY COMPRESSING ON ALL SIDES.

GALVANIZED STEEL MOUNTING BRACKETS.

SERIES 0701

L-PAD FOAM PAD TRUCK SHELTER

Designed for door openings up to 10'W x 10'H, the Series 0701 allows complete and unobstructed access to the full width and height of the trailer interior and shipping door while providing outstanding weather protection. The trailers back through the vertical pads forming a wiper seal that hugs the trailer's sides with an adjustable header curtain that sits on top of the trailer unit, thus allowing full access to the height of the trailer. The resilient vertical foam pads, covered with a large selection of tough abrasion resistant fabrics, create a tight seal that blocks out foul weather, insect, dust, dirt and may reduce pilferaging, while saving money on energy costs. Dock seals help productivity by increasing safety, protecting personnel, products and equipment.

SUPER SEAL

Tel: 905.850.2929 Tel: 1.800.337.3239
Fax: 905.850.2922 Fax: 905.850.4440

www.supersealmfg.com

SuperSeal Mfg. Ltd.
670 Rowntree Dairy Rd.,
Woodbridge, Ontario, Canada L4L 5T8

SPECIFICATIONS

Series 0701 Product Details:

- Series 0701 standard dimensions for door openings up to 10'W x 10'H are two (2) 129" high vertical pads with an 8" back, projection 16" to a 20" wide face and one (1) 136" long adjustable head curtain with a 30" drop.
- Seal trailers 11'6" to 13'6" high from level grade with a dock height of 48".
- A large selection of cover fabrics.
- Standard bottom draft seals for optimum seal.
- Minimal pressure on building wall since trailers back through the vertical foam pad rather than depressing them.
- Strongly recommend are the use of wear pleats over the base cover fabric.

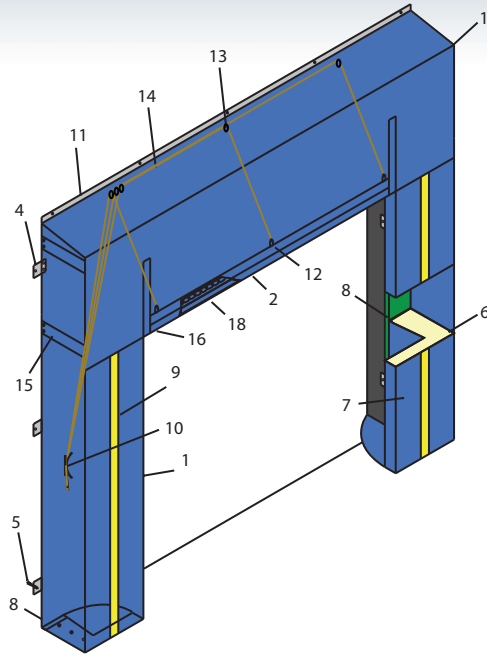

1. Vertical Pad
2. Adjustable head curtain
3. Air Vents
4. Galvanized steel mounting brackets
5. 3/8" sleeve anchor bolts
6. Polyurethane foam core
7. Cover fabric
8. Pressure Treated wood backing
9. 4" wide yellow guide stripe
10. Rope cleat
11. Head curtain retaining bar
12. "D" Rings
13. Pulleys
14. Rope
15. Head curtain restraining straps
16. Touch and hold Velcro split curtain (optional)
17. Steel tube
18. Weighted Chain

Specifications:

Dock door seal(s) to be Series 0701 as manufactured by Super Seal Mfg. Ltd., Woodbridge, Ontario. Dock door seal(s) to be manufactured using pressure treated wood, and high density, light weight urethane foam core with 98% compression recovery and maintaining flexibility at -40°. The foam core shall be continuously boned (not spot glued) to the wood backing with a high strength twisted 4ply 100% polyester bonded thread U.V. treated. The cover fabric overlaps the wood backing totally enclosing it and is fastened with heavy duty plated staples. Vertical pads are vented allowing air to be exhausted and moisture to drain. Vertical pads have 24" height 4" wide yellow guide strip to aid in spotting trailers. Unit shall come complete with a matching full width adjustable curtain. The curtain is manually adjusted by means of a rope and pulley assembly. Unit shall be furnished with all necessary mounting hardware, galvanized to resist corrosion.

Options:

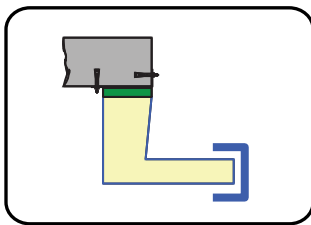

A. Cover material overlaps edges only

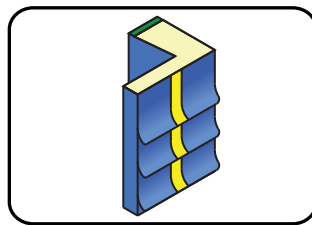

B. Protective flaps (4', 8', 16" Exposure)

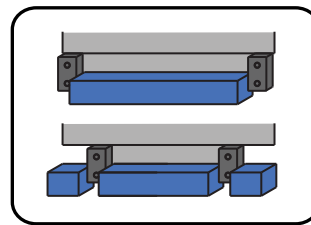

C. Bottom Pads

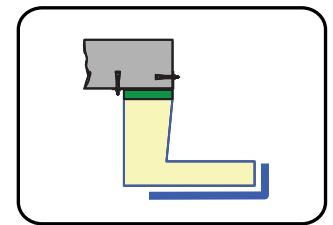

D. Double layer of fabric on impact area

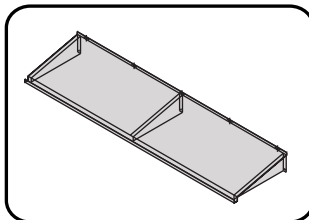

E. Galvanized steel canopy

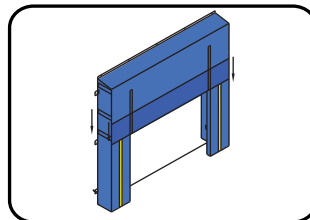

F. Longer drop curtain

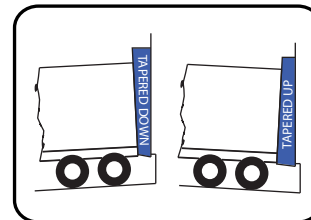

H. Tapered Units

